



Black & Decker[®]

Workmate[™]

Instruction Manual



T.M. Trademark *Black & Decker*

Your New *Workmate* the all purpose work centre and vise



Your new Workmate is a quality piece of equipment that has been carefully designed and manufactured to provide years of dependable service.

The instruction manual will familiarize you with the Workmate. It lists important facts and features which describe the Workmate's construction and basic operating techniques. Set up instructions and various usage situations are also provided.

Read this manual carefully. Only by being totally aware of what the Workmate can do will you be able to put it to the numerous tasks it is capable of performing.

Setting up the *Workmate*

The Workmate sets up easily into two working heights: the lower "sawhorse" height or the upper "workbench" height. Choose the position best suited to your particular job. In each case, the Workmate provides a safe and rigid work surface.

SAFETY RULES:

1. Do not load with more than 350 lbs.
2. Do not apply an unbalanced load which could cause the Workmate to tip.
3. Do not use lower platform as a step when Workmate is in workbench position.
4. Do not use Workmate as a stepladder or standing platform.
5. Do not store Workmate outdoors or in damp condition.
6. Avoid applying excessive force when clamping in only the lower half of the vise jaws or when using the swivel pegs.
7. Be sure that table locks in sawhorse position and that legs lock in workbench position.
8. When using a power tool with the Workmate, follow the safety rules in the tool's instruction manual.
9. Wear safety glasses when using power tools.
10. See "Using Power Equipment" (page 6) for correct method of securing power tools in Workmate. Never mount power tools directly in vise; pressure may damage tools.
11. An even pressure of jaws on work piece is essential. Tighten both jaw handles uniformly.

MAINTENANCE TIPS:

1. Pivot screws are of low friction design. No lubrication is necessary.
2. In binding of vise jaws occurs, cleaning or lubrication of slider and vise screw may be required.
3. Pivot screws should be checked for tightness.

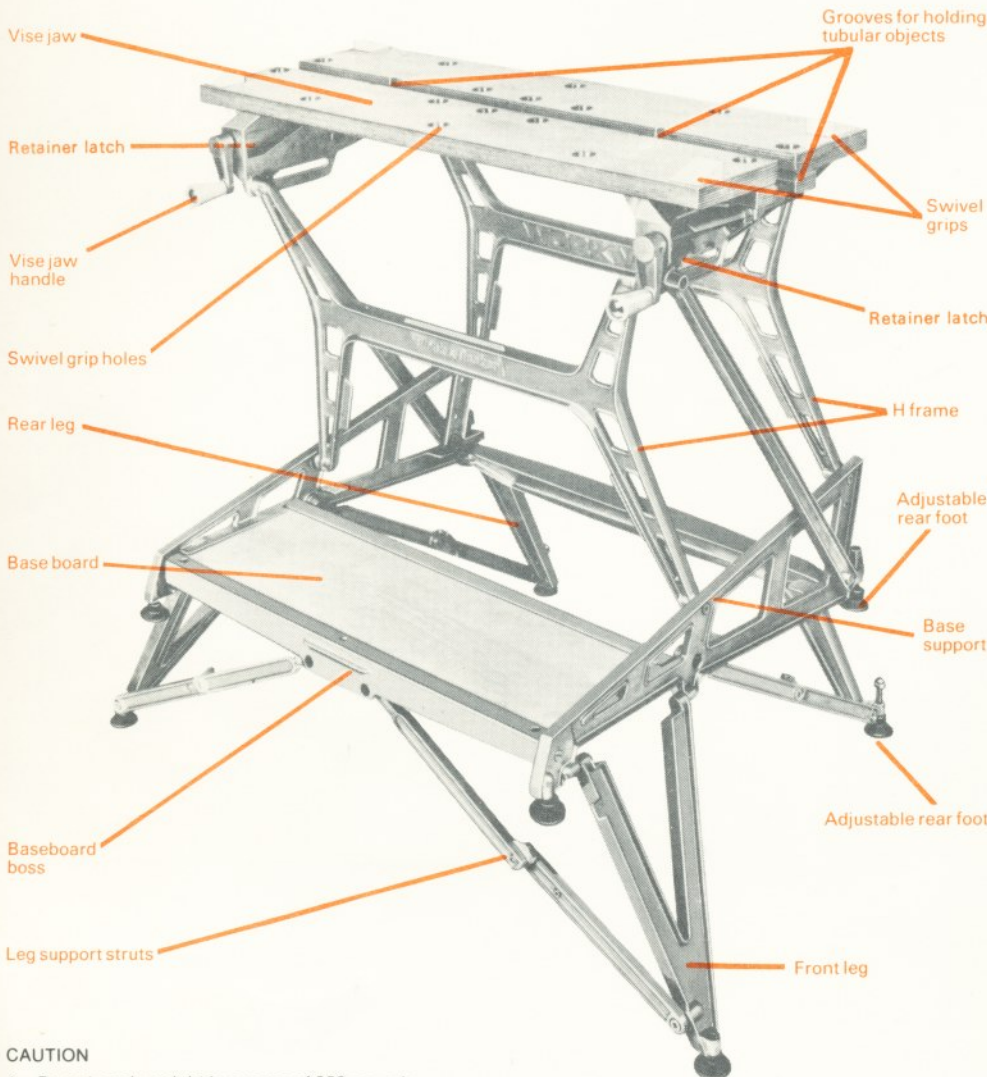

CAUTION

- 1.—Do not apply weight in excess of 350 pounds.
- 2.—Not to be used as a stepladder or standing platform.

**PROCEDURE BOTH MODELS
RECOMMENDED OPENING**

- 1 Start with the unit in a vertical position with the vise bars away from the body, see Fig. 1.
- 2 Lift both retainer latches and tilt the Workmate towards you to an angle of approximately 30°, see Fig. 2 and 2a.
- 3 Place one foot on the base board boss and exert a downward pressure to open the Workmate keeping both retainer latches in the lifted position, see Fig. 3.

- 4 Allow all the feet of the Workmate to rest on the ground. Fig. 4. Release the retainer latches and push the vise bars up and away from you through the intermediate positions (see Fig. 5) until you can push no further.

5 The unit is now fully erect and ready for use.

TO ERECT TO WORKBENCH HEIGHT

- 6 Tilt the Workmate away from you and pull out the two front legs located under the foot board (see Fig. 6). Ensure that leg support struts are fully extended, see Fig. 6a.

- 7 Tilt the Workmate towards you on its front feet, reach over the vise bars and open rear feet by applying pressure to both sides of the rear leg simultaneously, see Fig. 7 — recommended hand position is shown in Fig. 7a. Again ensure that the leg support struts are fully extended as for the front legs.

8 The unit is now fully erected and ready for use.

LEVELLING

The Workmate is fitted with height adjusting screws on the rear legs (see Fig. 8). If the floor surface on which the Workmate is standing is uneven, then the adjusters can be screwed in or out to compensate for surface irregularities.

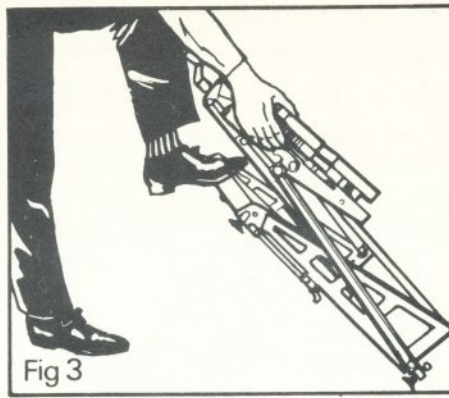

Fig 3

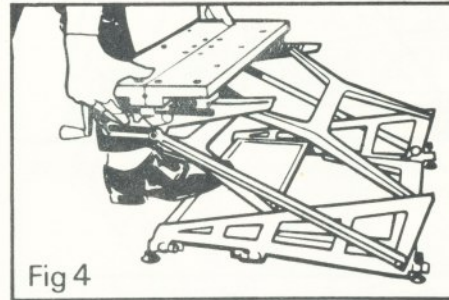

Fig 4

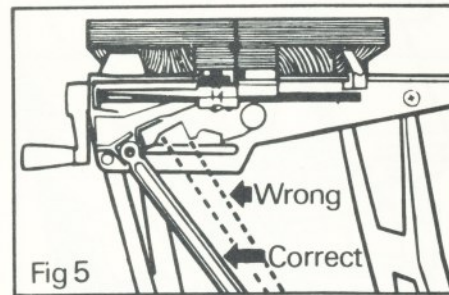

Fig 5

TO CLOSE THE WORKMATE

- 1 Stand in front of the unit with the vise handles towards you.
- 2 Tilt the Workmate towards you on its front legs.
- 3 Reach over the vise bars and bend both leg support struts before pushing the rear leg away under the Workmate, see Fig. 9 and 9a.
- 4 Tilt the Workmate away from you on to the lower height rear feet.
- 5 Bend the right or left leg support struts before folding the leg under the Workmate. Repeat for the remaining leg.
- 6 Lift the two retainer latches (see Fig. 2a) and the weight of the vise bars close the unit to a folded position.
- 7 Release the retainer latches which now lock the Workmate in this position.
- 8 Your Workmate is now ready to be taken easily to the next job or to be stored away.



Fig 7a

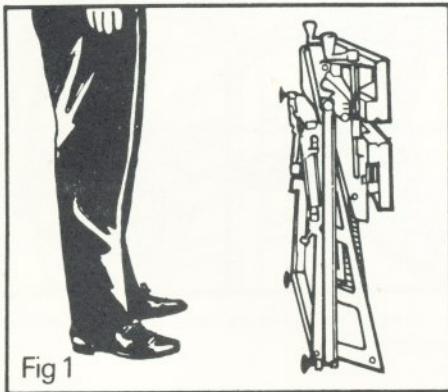

Fig 1

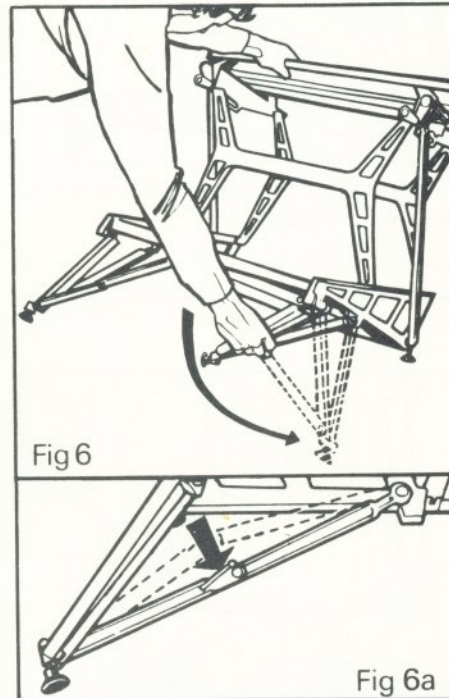

Fig 6

Fig 6a

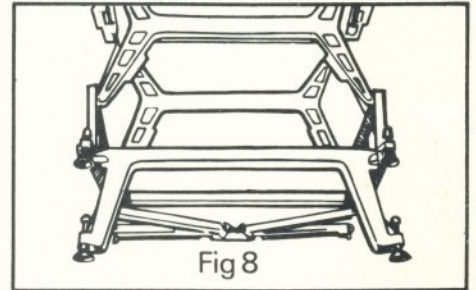

Fig 8

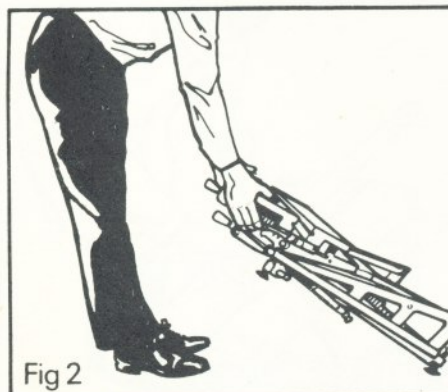

Fig 2

Fig 2a

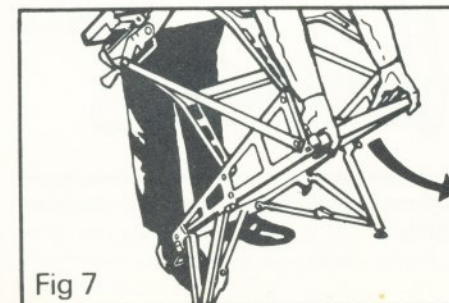

Fig 7

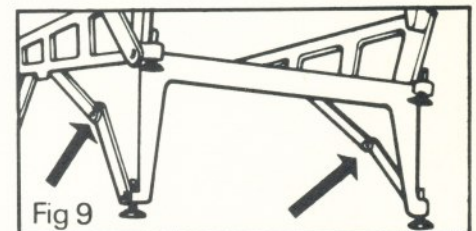

Fig 9

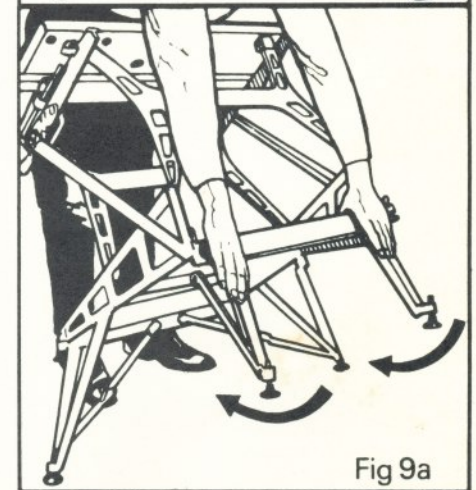

Fig 9a

Working with your *Workmate*

The Workmate is a vise, a sawhorse and an ideal workbench. Its basic design and special features help you to perform a complete range of workshop tasks from the simplest to the most complicated.

The heart of the Workmate is in the action of the two parallel vise jaws.

The two vise handles adjust the jaws to a maximum 4" jaw opening. Because each handle works independently, the opening can be tapered from 0" to 4" maximum.

Use of the swivel pegs in the appropriate vise holes extend the vise capacity of the Workmate to a 10" parallel or 24" diagonal grip.

Note: From illustration 4 to 13. The user's hands are free to hold the tools properly & safely.

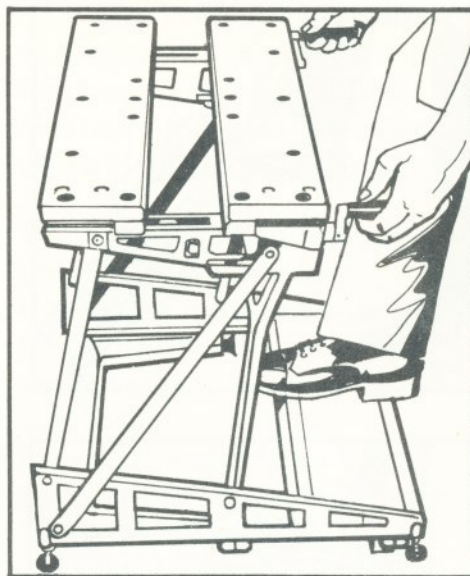

1. Adjusting the vise jaws with the vise handles.

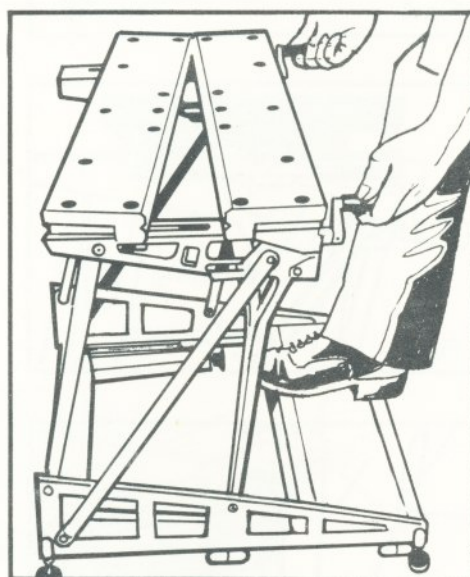

2. Tapering the vise opening using the independent vise handles.

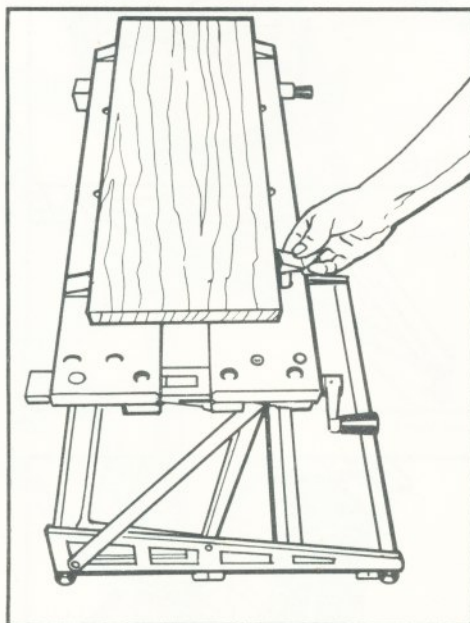

3. Using the vise pegs to extend the vise capacity.

Sawing

In its lower position, the Workmate is an ideal sawhorse.



4. For holding material safely and securely.

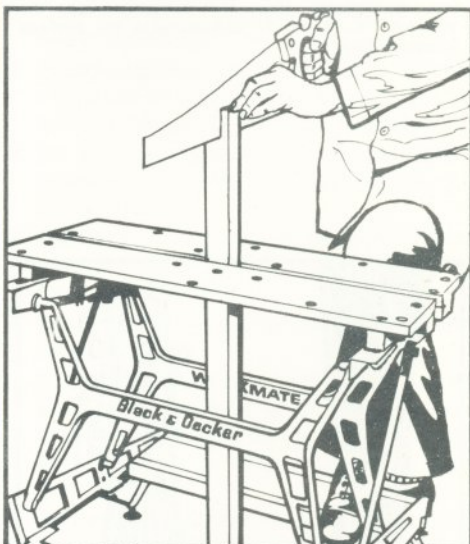

5. Gripping hard-to-hold objects while sawing.



6. Holding a mitre box for more accurate angle cuts. Note: for added rigidity, exert your body weight on the Workmate's base board when sawing or performing other tasks.



7. Sawing tubular pieces is easy when they are held horizontally in the specially designed V-grooves running along the face of the vise jaws.

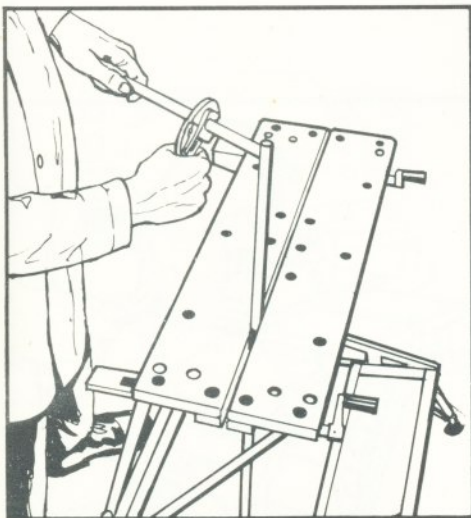

8. Similarly, vertical V-grooves in the face of the vise jaws permit rigid vertical grasping of tubular objects.

Planing, Sanding Routing

You can do a better job when the item you are working on is held steady and secure.



9. Holds your stock in the perfect height and position.



10. Strength and stability to handle the largest and most awkward sizes and shapes.

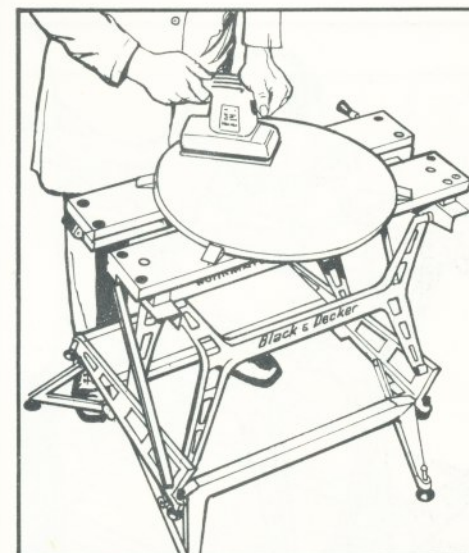

11. Power sand the most irregular shapes and use exactly the pressure that's needed. There are no sudden surprises when the item holds still.

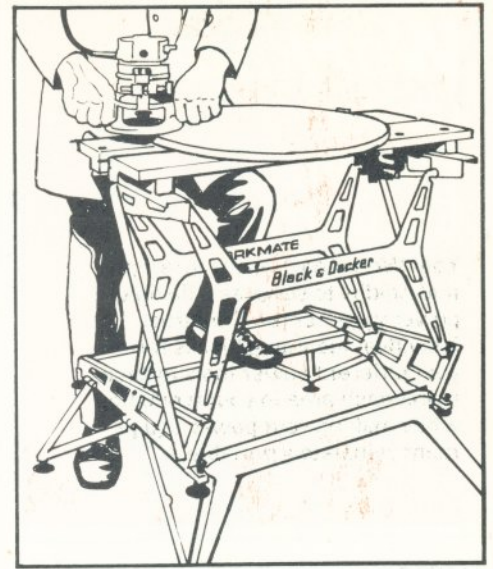

12. Special tasks won't mean special problems any more. Routing can be easy and the results more professional.

Workmate using Power Equipment

Your Workmate has the strength and rigidity to serve as a flexible power work center. Construct individual mounting blocks for your different power tools to save workbench area in your workshop while making your power equipment completely portable.

CAUTION:

1. Securely mount tool accessories to mounting board with screws or bolts.
2. For safety, it is recommended that you always wear safety glasses when using electrical tools with the Workmate.

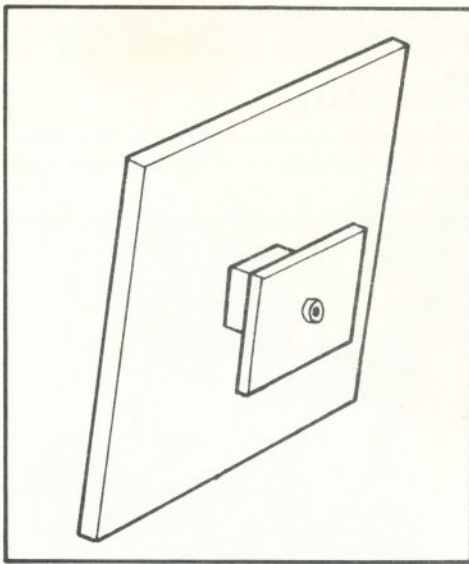

1. A simple power tool mounting board. (See back page for construction details.)

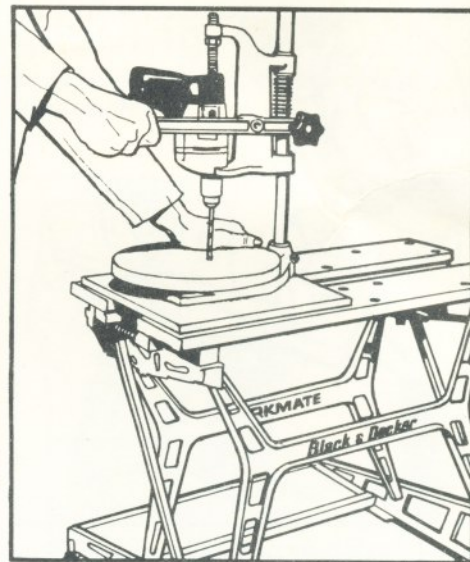

4. Your power drill and drill press can go along with you on any job—across town or into the next room.

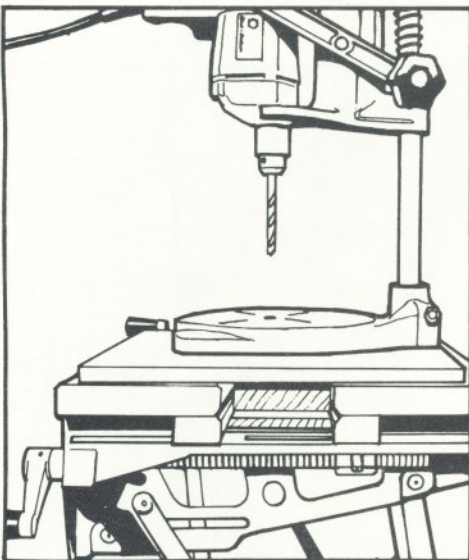

2. The block on the underside of the board is held in the jaws of the Workmate. The power unit is secure and safe for use.

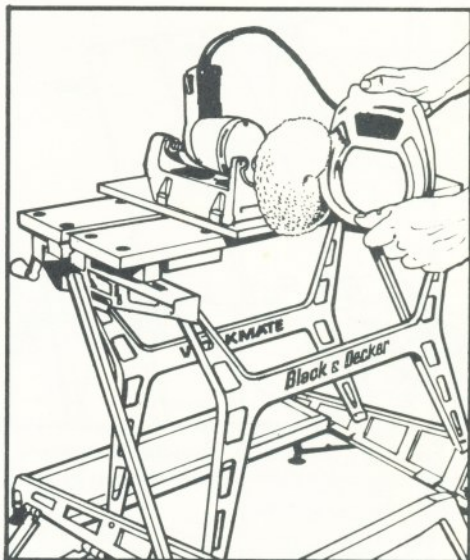

5. You'll want to use all of your power accessories more often. Take buffing—it's easier and more convenient with the Workmate.

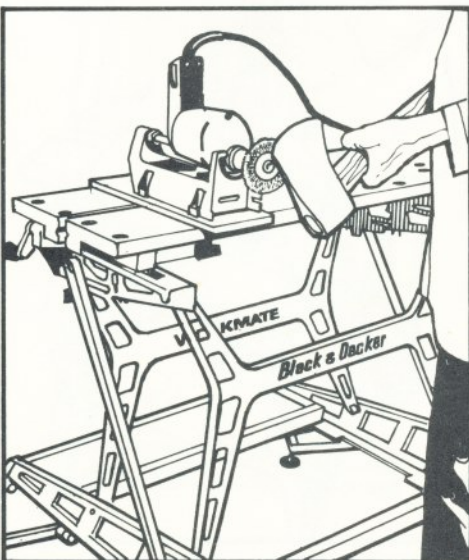

3. Set at the "workbench" height, the Workmate is a perfect mount for cleaning rusty tools and equipment.

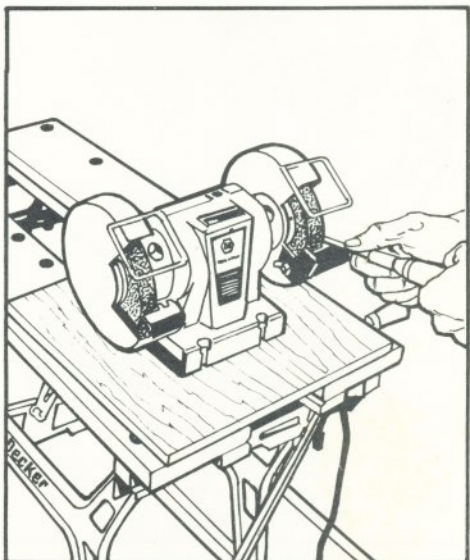

6. Add power equipment you never thought you had room for—grinding is safe and secure with the Workmate as your workbench.

Workmate Holding Irregular Shapes

Using the swivel grips in the appropriate holes and the independent action of the vise handle, the Workmate can secure the most irregular shapes. Lets you grip objects that used to be impossible to hold.

Rotate swivel peg to accept irregular shape.

Outside swivel grips extend vise capacity for a 24" diagonal grip.

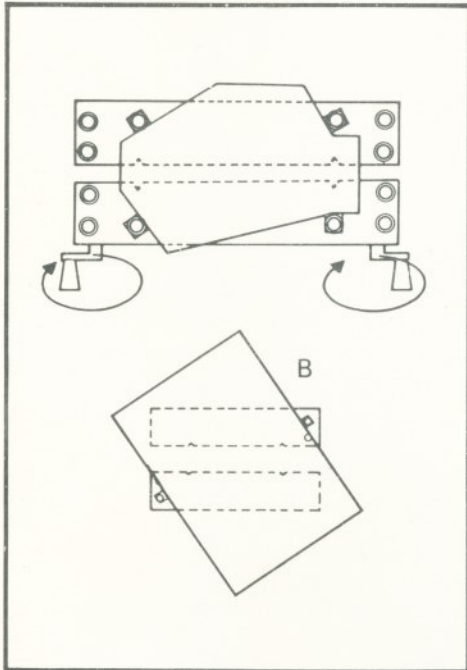

1. When the project calls for extra work space, you can shape up the perfect work table by attaching "block" (see section on "Power Tool Mounting Board") to the underside of a sheet of plywood. Helps with the wallpapering; makes an extra long table surface for any work or play occasion. Care should be taken to center plywood.

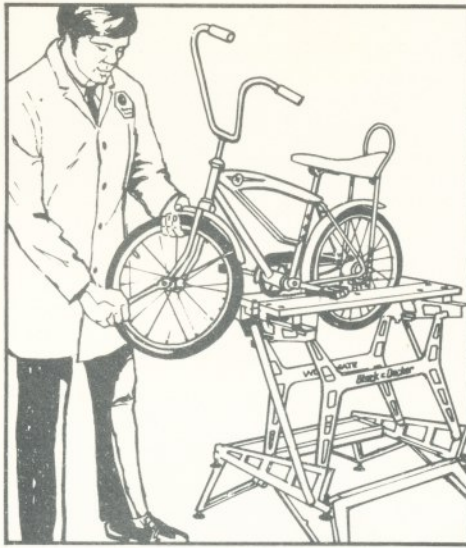

2. Got a bike that needs attention? The Workmate can make the job easier by giving you an extra pair of hands when you really need them.



3. The job gets done right the first time, and with less frustration, when the swivel grips get a hold on the problem.

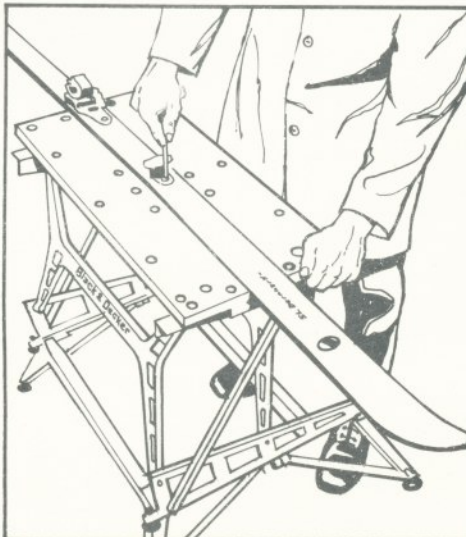

4. It's hard to find a shape that can't be held secure, and the object is always at the proper height to work on.

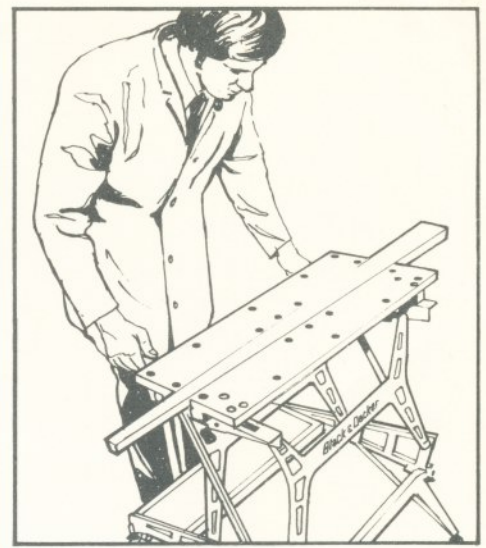

5. Because each end of the vise jaws work independently of each other, it's possible to grasp tapered objects.



6. If you've got a hobby or pastime that requires a steady hand and a steady work surface, rely on the Workmate. It's the vise and work center that lets you get at your project from any angle or position.

How To Store Your *Workmate*

1. Store swivel pegs upside down in table top until next application.
2. Fold the Workmate into its compact storage position (See page 3).
3. Your Workmate can then be stored in a closet or hung on a wall.

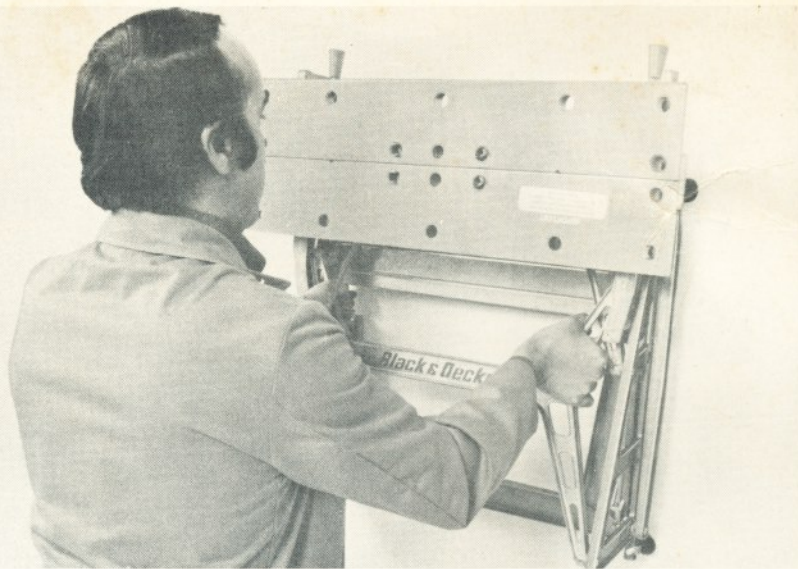

GUARANTEE



The Workmate is guaranteed for one year from date of purchase. If it does not operate to your complete satisfaction, it will be replaced free of charge when returned to the seller (if a participating retailer) or to a Black & Decker Service Center. Not applicable if used in commercial or rental service.

Simple fixtures for your *Black & Decker Workmate*

INTRODUCTORY NOTE

These simple fixtures represent a small selection of ideas designed to extend the already wide versatility of the Black and Decker Workmate. They are all intended to be gripped between the vise jaws. Relatively easy to make, they may be altered in size and material to suit individual requirements.

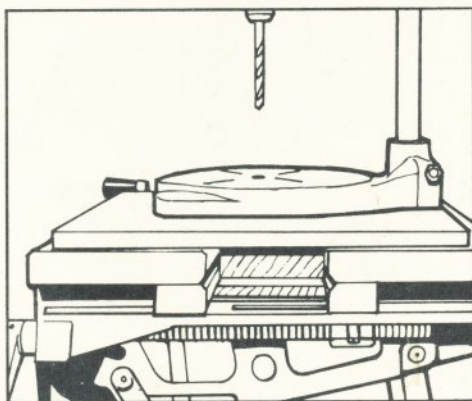

POWER TOOL MOUNTING BOARD

Attachments such as the Black and Decker Vertical Drill Stand, the Horizontal Drill Stand may be screwed down to a suitable sized piece of plywood, to the underside of which is attached a block. The Block when gripped securely in the Workmate vise jaws provides extra safety and accuracy in the operation of the attachment.

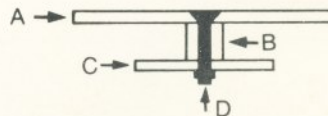

CAUTION:

1. Do not use nails or screws, use bolts
2. Do not overhang mounting board on working surface

SUGGESTED SIZES

- A-Mounting Board 12" x 12" x 3/8"
- B-Vise Block 2" x 4" x 6"
- C-Retaining Board 3" x 3" x 1/4"
- D-Bolt 5"

PASTING / GARDEN / GENERAL PURPOSE TABLE

CAUTION:

1. Do not use nails or screws, use bolts
2. Centre pasting board over table working surface

SUGGESTED SIZES

- 2' x 6' Plywood by 1/4"
- 2" x 4" Stud x 30" long
- 4 Bolts 5" long

